



F-7X
Smaze Machine
User Manual
- English
- 中文



1. Introduction	1
2. Safety Information.....	1
3. Package Contents & Inspection.....	2
4. Machine Details.....	3
5. Technical Label Information.....	3
6. Fog Fluid.....	3
7. Setting and Manual Operation.....	4
8. Control Settings.....	4
9. DMX Connection	6
10. RDM Function.....	6
11. EasySwitch Wireless Remote (Optional).....	7
12. EasySwitch W-DMX Receiver (Optional)	8
13. Service and Maintenance.....	9
14. Technical Specifications	10
15. Warranty Disclaimer.....	10
16. Machine Dimension.....	11
1. 前言	12
2. 安全注意事項	12
3. 包裝內容與檢查	13
4. 機器訊息	14
5. 技術標籤資訊	14
6. 煙霧水	14
7. 設定與手動操作說明	15
8. 控制設定	15
9. DMX 說明.....	17
10. RDM 功能.....	17
11. EasySwitch 無線控制器(選配).....	18
12. EasySwitch 無線 DMX 接收器(選配)	19
13. 維護和保養	20
14. 技術規格	21
15. 保固聲明	21
16. 機器尺寸圖	21
Appendix I Grounding Instruction	22





User Manual

1. Introduction

Please read all the user manual before operating the machine, and place the manual where the user can refer to it at all time. The manual includes how to install and operate the machine under safe conditions and explain all the labels printed on the machine. If you encounter any problem, contact your local Antari dealer for assistant immediately.

2. Safety Information

 DANGER	If the danger is not avoided, it will cause death or serious injury
 WARNING	If the warning is not heeded, it can cause death or serious injury.
 CAUTION	If the precaution is not taken, it may cause minor or moderate injury.



DANGER

- Must connect the machine to the correct rated voltage or it might lead to an electrical shock or a burn and may cause serious consequences.
- Must connect the machine to a protected circuit and ensure it is properly grounded to avoid the risk of electrocution. For grounding instruction, please refer to Appendix I on page 22.
- Do not operate the machine with a bundled power cord, it could lead to a fire hazard.
- When operating the machine, do not point at people, animals, or fire.



WARNING

- Please operate the machine on a flat, level hard and well-ventilated surface area, reserve at least 50cm space around the machine and make sure there is no flammable gas or material nearby.
- Do not disassemble, repair or modify the machine, it may cause damages, malfunction, risk of electrical shock or result in fire.
- The machine can only be operated by adults or professionals, is not intended for use by person with reduced physical sensory, mental capabilities, or lack of experience and knowledge including children.
- Do not leave the machine running unattended, make sure all powers are off when leaving.
- Children should be supervised to ensure that they do not play with the machine.
- Do not use the machine upside down or tilt it, it might cause damages or malfunction.
- Please store the fluid inside in a well-ventilated area without direct sunlight and keep out of reach of children. In case of eye contact or accidentally swallow the fluid, please seek medical attention immediately.



CAUTION

- Keep the machine dry at all time. The machine is not waterproof, do not expose the machine to water, rain or moisture environment.
- Please make sure the power outlet is not damaged or loose before plug in the power cord.
- If the power cord is damaged, it must be replaced by Antari or its local dealers, otherwise the warranty will be void.
- Before transporting the machine, please make sure the fluid is drained and tank is empty. (Recommend using original package)

- The machine is for indoor use only.
- Do not operate the machine in any area with unstable voltage.
- If you experience strange sound or malfunction, turn off the power and unplug the power cord immediately and contact your local Antari dealer for assistant.
- Do not contact any moving part.
- Only use accessories recommended or sold by Antari.
- Please make sure the power is off when not using the machine and unplug the power cord if not intend to use for a long period of time.
- To disconnect, turn all controls to the off position, then remove plug from outlet.
- Do not unplug by pulling on cord. To unplug, grasp the plug, not the cord.
- Unplug from outlet before servicing or cleaning.
- Do not operate the machine with a damaged cord or plug, or after the machine malfunctions or is dropped or damaged in any manner. Return machine to the nearest authorized service facility for examination, repair, or electrical or mechanical adjustment.
- To ensure the lifespan of the machine, please only use the fluid manufactured by Antari, do not use other fluid or additive, otherwise it may cause malfunction.

Before operating the machine, please read all warning labels on the machine, description as below;

Rear Cover Printing

WARNING!

DISCONNECT POWER BEFORE CHANGING FUSE.
 USE ONLY WITH ADULT SUPERVISION.
 DO NOT OPERATE WITHOUT LIQUID.
 FOR INDOOR USE ONLY. KEEP DRY.
 NO USER SERVICEABLE PARTS INSIDE.

CAUTION!

ONLY USE MANUFACTURER DESIGNATED FLUID.
 NEVER ADD FLAMMABLE SUBSTANCES.

3. Package Contents & Inspection

Immediately upon receiving the machine, carefully unpack the carton, check the content to ensure it is the correct model and all parts are included. If any part appears to be damaged or missing during transportation, please contact your local dealer and return in original package for inspection.

3.1 Package Contents

- 1 x F-7X Smaze Machine
- 2 x 5 Liter Fluid Tank
- 2 x Neutrik powerCON Power Cable
- 1 x User Manual or Scan QR Code on the Machine

3.2 Optional Accessories

Item Code	Description
ES-W2-RECEIVER	EasySwitch Wireless Remote (Wireless Receiver/W-2 Wireless Transmitter)
ES-W-DMX	EasySwitch Wireless DMX Receiver

4. Machine Details

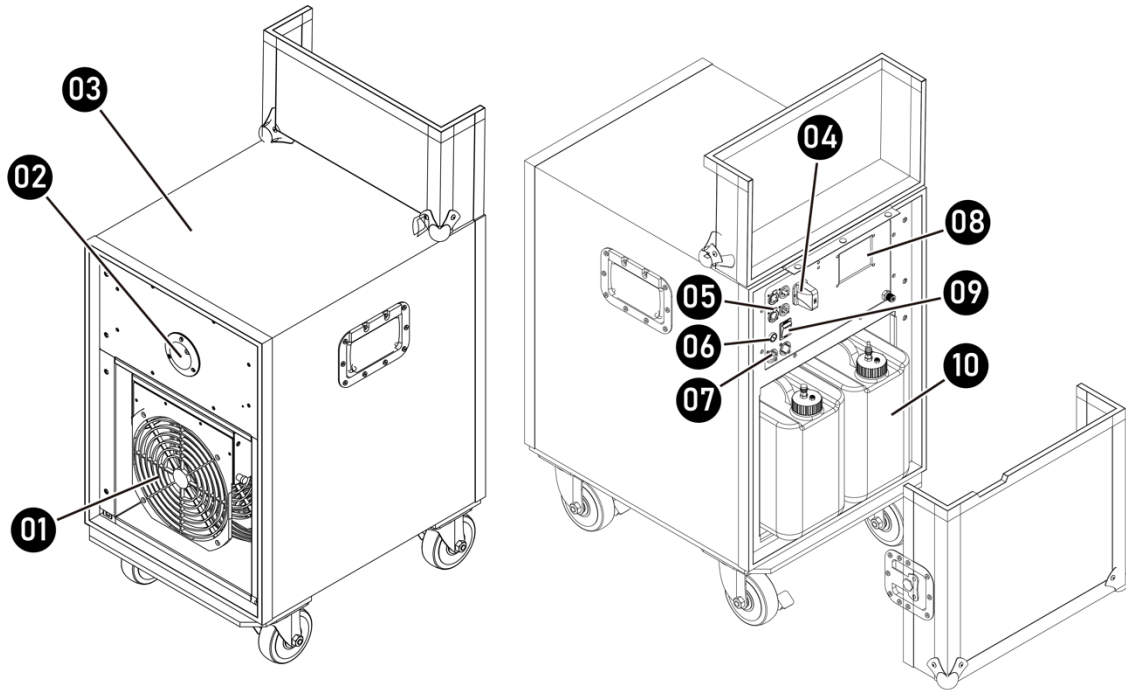

01. Fan	06. Fuse
02. Nozzle	07. Neutrik powerCON Connector (Power)
03. Flight Case	08. LCD Touch Screen
04. Wireless / W-DMX (Optional)	09. Two in One Power & Breaker Switch
05. XLR 3-Pin/5-Pin Connector (DMX)	10. 5 Liter Fluid Tank

5. Technical Label Information

Please read the technical label information on the back of the machine before operating it.

1. Model Name	5. Breaker/Fuse
2. Input Voltage	6. QR CODE for User Manual
3. Frequency	7. Serial No.
4. Rated Power	

6. Fog Fluid

 CAUTION	<p>Always turn off the power before filling the fluid tank. Do not add flammable liquid to the fluid tank. If fluid gets inside the machine, please contact your local Antari dealer for assistant.</p>
--	---

- Only the fog fluid manufactured by Antari can be used, do not mix or dilute the fog fluid. Due to improper storage or using other fluid might cause malfunction.
- The machine is tested and calibrated with the specific fog fluid to get the best performance.

- Please empty the fluid in the tank before switching to another fluid to avoid mixing.
- The warranty on your fog machine will be void if you use fog fluid not manufactured by Antari.

7. Setting and Manual Operation

	WARNING	Machine falling off might cause serious injury, please make sure it is secure and firm on the overhead.
---	----------------	---

- Step 1.** Place the machine on a flat, level hard and well-ventilated surface area and reserve at least 50cm open space around the machine, and make sure there is no flammable gas or material nearby;
- Step 2.** Fill the fluid tank with Antari approved fog fluid, and make sure the tube is not twisted;
- Step 3.** Connect the machine to the power outlet. Please read the technical label on the back of the machine and make sure the power outlet is the correspond to the rated voltage for the machine;
- Step 4.** Turn on the machine, warm up process takes approximately 8 minutes. Once the machine is ready for operation, the LCD display will show “Ready To Faze”;
- Step 5.** Please refer to “8. Control Settings” for control panel operation;
- Step 6.** To turn off the machine, please make sure the machine is not operating then turn of the power. If you will not use the machine a long period of time, please remove the power cord.

8. Control Settings

F-7X Smaze Machine can be operated in the following modes. The machine can only accept 1 type of signal at a time.

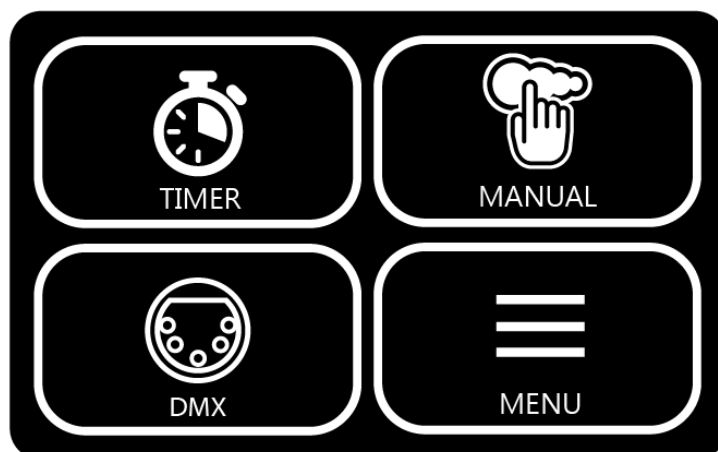

- Manual
- Timer
- DMX512
- Wireless
- W-DMX

8.1 Control Panel Description



F-7X Smaze Machine can be operated with LCD Touch Screen.

Icon	Operating Method	Action
✓	Press	Confirmed Selection
◀▶	Press	Adjust Values
↶	Press	Back to Last Page
▶	Press	Start

Icon	Operating Method	Action
	Press	Stop
	Press	Enter Configuration
 (Green Background Color)	N/A	Selected Mode in Action

8.2 Menu Options Description

Main Menu	Item	Description	
Timer	Operation Mode	Fog / Faze	
	Interval	1 – 300 sec	
	Duration	1 – 120 sec	
	Fog Output	20 – 100%	
	Faze Output	20 – 100%	
	Fan Level	20 – 100%	
Manual	Operation Mode	Fog / Faze	
	Fog Output	20 – 100%	
	Faze Output	20 – 100%	
	Fan Level	20 – 100%	
DMX	Address	001 - 510	
	WDMX On	On / Off	
	WDMX Reset	On	
Menu	Information	Software Version	
	Setting	Operation Mode	Fog / Faze
		Fan Level	20 – 100%
		Fluid Selection	FLG / FLZ / FLH
		Fluid Detection	On / Off
		WRC Pairing	Pair / Unpair
		Quick Start	On / Off
		Language	中文 / English / 日本語
	LCD Backlight	High / Normal / Low / Auto Off	
Self-Cleaning Mode	Count Down 180 sec		

9. DMX Connection

9.1 DMX Connector Pin Assignment

The machine has a XLR 3-Pin and 5-Pin for DMX connection. The diagram below indicates pin assignment information.

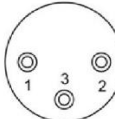
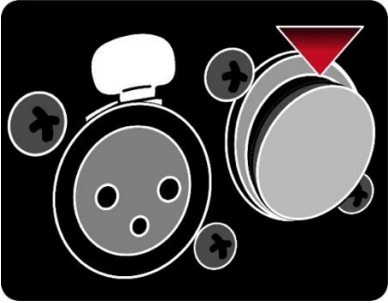
 3 Pin XLR	 5 Pin XLR	<p>** There is a protection cap on DMX IN, please remove it with your finger before operation.</p> 											
<table border="1"> <thead> <tr> <th>Pin</th> <th>Function</th> </tr> </thead> <tbody> <tr> <td>1</td> <td>Ground</td> </tr> <tr> <td>2</td> <td>Data-</td> </tr> <tr> <td>3</td> <td>Data+</td> </tr> <tr> <td>4</td> <td>N/A</td> </tr> <tr> <td>5</td> <td>N/A</td> </tr> </tbody> </table>			Pin	Function	1	Ground	2	Data-	3	Data+	4	N/A	5
Pin	Function												
1	Ground												
2	Data-												
3	Data+												
4	N/A												
5	N/A												

9.2 DMX Channel Function

The machine provides 3 DMX Channels to select from, please see chart below.

Channel Mode	Channel	DMX Value Range	Function
Channel 1	1	0 – 127	Faze Mode
		128 – 255	Fog Mode
Channel 2	2	0 – 5	Output Off
		6 – 255	Output 21%– 100%
Channel 3	3	0 – 5	Fan Speed 20%
		6 – 255	Fan Speed 21% – 100%

10. RDM Function

M-12 Universal Voltage Fog Machines is RDM enabled, allowing control system to configure, monitor and manage. See below table for supported RDM categories and parameters.

10.1 RDM UID

ESTA Manufacturer ID (16-bit)		Device ID (32-bit)			
Fixed		Fixed		RDM UID Range: 0x0000 ~ 0xFFDC	
0x1E	0xD8	0x00	0x0C	0x00	0x01

※RDM UID can be set in Factory Mode

10.2 RDM Categories/Parameter ID Defines

GET Allowed	SET Allowed	Category	RDM Parameter ID's	Value	Required
		Network Management	DISC_UNIQUE_BRANCH	0x0001	O
			DISC_MUTE	0x0002	O
			DISC_UNMUTE	0x0003	O
O		RDM Information	STATUS_MESSAGES	0x0030	
O			SUPPORTED_PARAMETERS	0x0050	O
O		Product Information	DEVICE_INFO	0x0060	O
O			PRODUCT_DETAIL_ID_LIST	0x0070	
O			DEVICE_MODEL_DESCRIPTION	0x0080	
O			MANUFACTURER_LABEL	0x0081	
O	O		DEVICE_LABEL	0x0082	
O			SOFTWARE_VERSION_LABEL	0x00C0	O
O	O	DMX512 Setup	DMX_PERSONALITY	0x00E0	
O			DMX_PERSONALITY_DESCRIPTION	0x00E1	
O	O		DMX_START_ADDRESS	0x00F0	O
O	O	Control	IDENTIFY_DEVICE	0x1000	O

11. EasySwitch Wireless Remote (Optional)

EasySwitch Wireless Remote is an optional accessory for F-7X Smaze Machines, it included a W-2 wireless transmitter and an EasySwitch Wireless Receiver. If you already purchased the wireless model, it's ready to use. If you purchase the EasySwitch Wireless Remote afterwards, please follow the instruction below. If you encounter any problem, please contact your local Antari dealer for assistant.

11.1 W-2 Wireless Transmitter & EasySwitch Wireless Receiver

- Battery : 27A 12V
- Effective Range : The effective range is approximately 50 meter, depends on actual condition, it may vary.
- If effective range is significantly shorter, please change battery.
- W-2 wireless transmitter has 4 buttons, each function as follow:

Button	Function
[A]	Start Fogging
[B]	Stop Fogging
[C]	Increase Fog Output
[D]	Decrease Fog Output



W-2 Wireless Transmitter

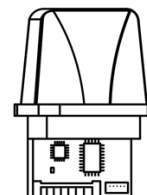

EasySwitch Wireless Receiver

11.2 EasySwitch Wireless Receiver Installation

If you purchased the EasySwitch Wireless Remote afterwards, please follow the instructions below to install the receiver. If you encounter any problem, please contact your local Antari dealer for assistant.



Graph 1

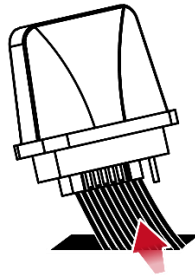

Graph 2



Graph 3

1. Please see graph 1, remove the cover from the pointed place;
2. You will see a white cable like graph 2, pull it out and connect to the EasySwitch wireless receiver;
3. Screw it back to the machine show in graph 3 and follow the instruction on 11.3 for pairing.

11.3 Pair & Unpair

Each receiver can pair up to 5 transmitters, please follow the steps below to pair or unpair the transmitters;

Step 1. Press menu to enter;

Step 2. Press setting and find WRC Pairing;

Step 3A. Press Pair to pair the W-2 Wireless transmitter;

Step 3B. Press Unpair to unpair the W-2 Wireless transmitter;

12. EasySwitch W-DMX Receiver (Optional)

EasySwitch W-DMX Receiver is an optional accessory for F-7X Smaze Machines, it included a EasySwitch W-DMX receiver. If you already purchased the W-DMX model, it's ready to use.

please follow the instruction below. If you encounter any problem, please contact your local Antari dealer for assistant.

12.1 EasySwitch W-DMX Receiver

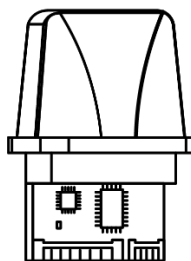

12.2 EasySwitch W-DMX Receiver Installation

If you purchased the EasySwitch Wireless Remote afterwards, please follow the instructions below to install the receiver. If you encounter any problem, please contact your local Antari dealer for assistant.

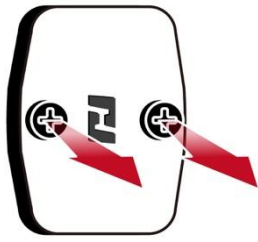

Graph 1

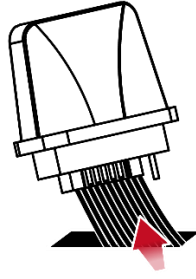

Graph 2



Graph 3

1. Please see graph 1, remove the cover from the pointed place;
2. You will see a white cable like graph 2, pull it out and connect to the EasySwitch wireless receiver;
3. Screw it back to the machine like graph 3 and follow the instruction on 12.3 for pairing.

12.3 Pair & Unpair

Please follow the steps below to pair;

- Step 1.** Press DMX;
- Step 2.** Press WDMX On;
- Step 3A.** Press On to link for signal;
- Step 3B.** Press Off to unlink W-DMX signal;
- Step 4.** Or Press WDMX Reset and press On to reset.

12.4 Status of W-DMX

Symbol on the Liquid Crystal Display	Status of W-DMX connection
●	Transmitter assigned, DMX signal received
◎	Transmitter assigned, No DMX signal
⊙	Transmitter link lost or linking to transmitter
○	Transmitter not assigned

13. Service and Maintenance

	DANGER	Disconnect the power cord before starting maintenance operation.
---	--------	--

- Always keep the machine clean and dry.
- Can use an air compressor, a vacuum or a soft brush to remove the dust on the machine.
- Can use a slightly damp cloth to clean the casing.
- It is recommended to run the machine at least once a month in order to maintain its best performance and output condition.
- Excessive dust and build up liquid residue will reduce the performance and cause overheat.

13.1 Breaker Reset (2 in 1 Power Switch)

The 2 in 1 power switch combines power and breaker function.

Please follow below steps to reset the breaker;

Step 1: Please switch to the OFF position;

Step 2: Wait 60 seconds;

Step 3: Flip switch to ON position.

**If the breaker (switch) still jumps off after reset, please contact your local Antari dealer for assistance.

Breaker Specification

100-120V = 15A 250V

220-240V = 9A 250V

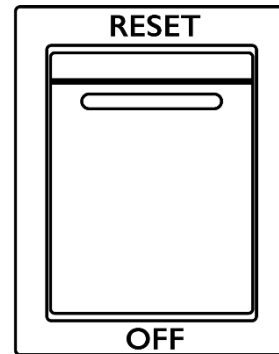

14. Technical Specifications

F-7X	
Input Voltage	US Model : AC 100-120V, 50/60Hz 13.5A EU Model : AC 220-240V, 50/60Hz 8.0A
Rated Power	100V 1400W / 120V 1600W / 240V 1900W
Warming-up Time	8 minutes (approx.) (Fog Mode)
Fluid Consumption	Fog Mode: 150 ml/min (100% Output) Faze Mode: 28 ml/min (100% Output)
Fluid Tank Capacity	5 Liters (1.32 gallon) x 2
Compatible Fluid	Antari FLG-5E 、 Antari FLH-5E 、 Antari FLZ-5E
Operating Time	2.8 hrs (100% output) (Faze Mode)
Ambient Temp. Range	0°C – 40°C (32°F – 104°F)
Control Methods	Manual 、 Timer 、 DMX512 、 Wireless (Optional) 、 W-DMX (Optional)
Interface	XLR 3-Pin/5-Pin Connector (DMX) 、 Neutrik powerCON Connector (Power)
DMX Channels	3 Channels
Included Accessories	N/A
Optional Accessories	EasySwitch Wireless Remote 、 EasySwitch W-DMX
Dimension	L 728 W 428 H 719 mm (L 28.66 W 16.85 H 28.31 inch)
Weight	53.0 kg (116.85 lbs.)

15. Warranty Disclaimer

We guarantee the merchandise manufactured by us to be free from defect in material and workmanship for a period of one year. Our obligation and liability under this warranty shall be restricted to repair or replacement at our factory or local authorized dealer. We assume no liability of the products that are improperly used or used for any purpose other than that for which they are specially designed. This warranty shall not apply to any merchandise which has been repaired, altered or assembled outside our factory in any way so as in our judgment to affect its performance, nor which has been subjected to misuse, negligence, or accident nor to any merchandise operated contrary to our printed instructions. We will not allow or be liable of any loss or any damages of any kind in connection with the use, sale, or repair of any merchandise purchased from us.

16. Machine Dimension

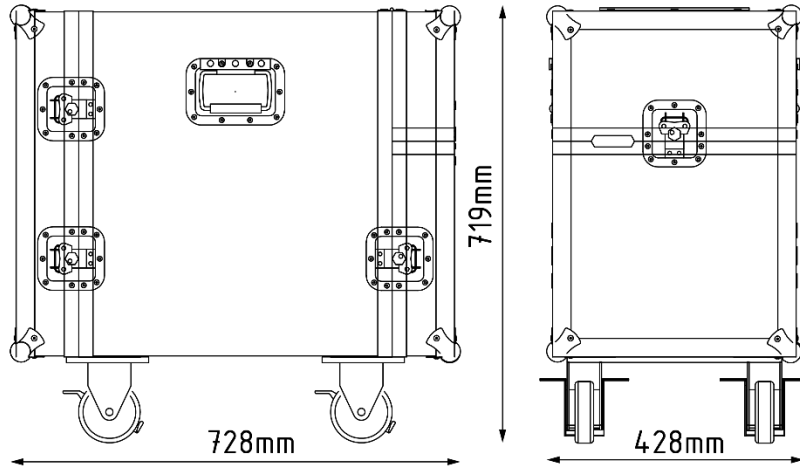





中文使用說明書

1. 前言

在操作本機器之前，請務必仔細詳閱本說明書然後請將本說明書放置在機器使用者可隨時查閱之處存放。此說明書包含如何安全的安裝及操作本機器以及說明所有在機器上的標示。如果您有任何操作上的問題，請立即聯繫當地的 Antari 經銷商尋求協助。

2. 安全注意事項

	危險	若不確實避免這些指示，可能導致嚴重人身傷害甚至死亡。
	警告	若不確實遵循這些指示，可能導致嚴重人身傷害甚至死亡。
	注意	若不確實注意這些指示，可能導致人身傷害甚至死亡，嚴重程度視情況而定。



危險

- 請務必使用正確電壓。如果使用錯誤電壓，可能會遭受危險的電擊燒傷或更嚴重的後果。
- 請務必將機器連結到有保護的電路，並確保有正確的接地，以避免觸電的危險。關於接地方式請參考第 22 頁附錄 I。
- 請勿在捆綁電源線的情況下使用，可能會發熱導致火災。
- 操作機器時請勿將機器對著人體、動物或火焰使用。



警告

- 請於堅固、平坦、穩定且通風良好的表面上使用機器。請勿遮蓋機器散熱部份，機器周邊至少應保留 50 公分的空間並確認附近沒有易燃性物質或可揮發性氣體。
- 請勿隨意拆卸、修理或改造機器，這可能會導致機器故障、損壞、觸電危險或造成火災。
- 本機器僅限有行為能力之成人或專業人員操作，不預期提供生理、感知、心智能力、經驗或知識不足者之使用者(包含孩童)使用本機器。
- 請勿在無人看管時讓機器運作，並於外出離去時確實關閉電源。
- 孩童應受監督，以確保孩童不能操作或嬉戲玩本機器。
- 請勿將機器倒放或傾斜使用，可能導致機器動作不正常或損壞。
- 請將液體存放在室內孩童無法取得之處，保持通風及避免陽光直射。如果有觸碰眼睛或誤食機器，請立即尋求醫生的協助。



注意

- 本機器無防水設計，請隨時保持機器乾燥，嚴禁將其潑水、浸水、淋雨或放在潮溼的環境。
- 在插入電源插座前，請確認電源插座無損壞或鬆動。
- 若電源線損壞，必須使用原廠電源線或組件進行更換，否則將導致保固無效。
- 在運輸本機器前，請確認機器的油箱已清空並且包裝完整。(建議使用原廠包裝)

- 本產品僅限室內使用。
- 請勿在電壓不穩定的地區使用本機器。
- 如果機器出現異常聲音或有任何不正常現象時，請立即停止工作，將電源關閉及拔下機器電源線，並請聯繫當地的 Antari 經銷商尋求協助。
- 請勿觸碰機器內部運轉零件。
- 只能使用原廠建議或販售之配件。
- 請確認機器不在使用的狀態下電源已關。如果長時間不使用機器，請拔掉電源線。
- 關閉機器時，將控制開關轉到關閉的位置，然後再將插頭從插座拔除。
- 拔除電源線時，請抓住插頭不是電線。
- 在保養及清潔前，請把電源線從插座拔除。
- 在電線或插座有損毀、機器故障或有掉落或損壞的情形發生時，請勿操作機器。請將機器送回最近的維修站，做檢查、維修及電源或機械的調整。
- 為確保機器的使用壽命，請使用 Antari 原廠製造之煙霧水，勿使用其它非 Antari 原廠製造煙霧水或添加劑，否則可能會導致故障。

在使用本機之前，請詳細閱讀機器上的警語標示，說明如下：

後蓋印刷

WARNING! 警告!

DISCONNECT POWER BEFORE CHANGING FUSE. 更換保險絲前請務必斷開電源
 USE ONLY WITH ADULT SUPERVISION. 僅在成人監督下使用
 DO NOT OPERATE WITHOUT LIQUID. 請勿在沒有液體的情況操作本機台
 FOR INDOOR USE ONLY. KEEP DRY. 僅限室內使用 請保持乾燥
 NO USER SERVICEABLE PARTS INSIDE. 內部無使用者可維修之零配件

CAUTION! 警告!

ONLY USE MANUFACTURER DESIGNATED FLUID 只限使用製造商指定液體
 NEVER ADD FLAMMABLE SUBSTANCES. 請勿添加易燃物質

3. 包裝內容與檢查

在收到機器後，請立即小心地打開包裝紙箱，檢查所有內容，確認您所購買的機型及配件。如果有任何部件因運輸過程出現損壞或缺少，請立即連絡經銷商，並以原包裝退回檢查。

3.1 包裝內容

- 1 x F-7X 煙霧薄霧兩用機
- 2 x 五公升油桶
- 2 x Neutrik powerCON 電源線
- 1 x 說明書或掃描機身 QR CODE

3.2 選配說明

品項	描述
ES-W2-RECEIVER	EasySwitch 無線控制器(無線接收器和 W-2 無線發射器)
ES-W-DMX	EasySwitch 無線 DMX 接收器

4. 機器訊息

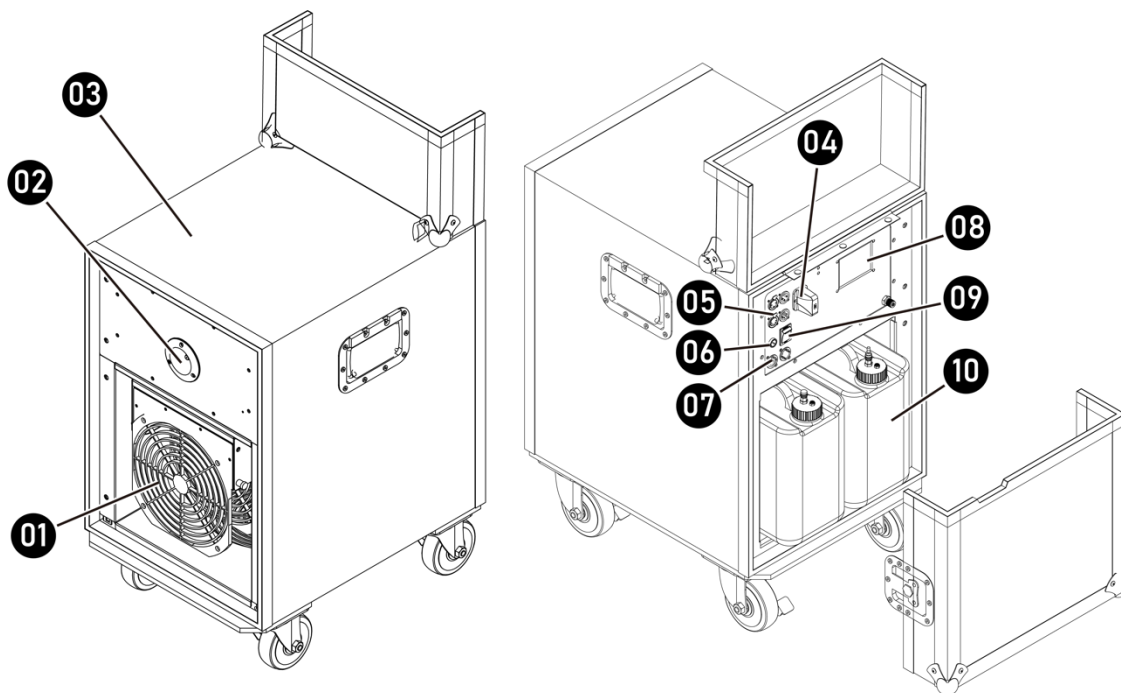

01. 風扇	06. 保險絲
02. 出煙口	07. Neutrik powerCON 連接頭(電源)
03. 飛行箱	08. 液晶觸控螢幕
04. 無線 / 無線 DMX 接收器(選配)	09. 二合一電源&斷路器開關
05. XLR 3-Pin/5-Pin 連接頭(DMX)	10. 五公升油桶

5. 技術標籤資訊

使用本機器前，請詳閱技術標籤上的訊息

1. 機器型號	5. 斷路器/保險絲
2. 工作電壓	6. 說明書 QR CODE
3. 頻率	7. 機器流水序號
4. 瓦特數	

6. 煙霧水

	危險	將液體加入機器之前，請務必先拔除電源線。請勿添加易燃液體。如果發現液體流入機器內部，請洽 Antari 原廠或其經銷商尋求協助。
---	-----------	--

- 僅能使用 Antari 原廠製造之煙霧水，不可混用或稀釋。若因保存不當而變質或使用非原廠煙霧水，將可能造成機器故障。
- 本機器是使用專屬的煙霧水做測試與校正來取得最佳的效能。

- 如需更換另一種液體，請在使用前，先將油桶中的液體清空，以避免混合。
- 如果使用非原廠製造之煙霧水而導致煙霧機損壞將不在保固範圍內。

7. 設定與手動操作說明

	警告	機台掉落可能會造成嚴重傷害，請確保本機台安裝牢固且不會掉落。
---	-----------	--------------------------------

- 步驟1.** 將機器平放在堅固、平坦、穩定且通風良好的表面上，機器周圍至少應保留 50 公分的空間並確認附近沒有易燃性物質或可揮發性氣體；
- 步驟2.** 使用用 ANTARI 原廠專用煙霧水注入機器所附的油桶，並注意不要折到油管；
- 步驟3.** 將機器連接電源，連接之前，確認機器背後技術標籤上所標示要求功率，是否與電源插座相符；
- 步驟4.** 啟動機器電源後，機器開始加熱。機器加熱到可工作溫度大約需要 8 分鐘。當機器已經準備好可進行操作時，螢幕會顯示“Ready to Faze”；
- 步驟5.** 參照”8.控制設定”，使用控制面板控制機器；
- 步驟6.** 需關閉本機時，請確認機器已停止運轉，再將電源開關關閉即可，長時間不使用時請移除電源線。

8. 控制設定

F-7X 煙霧薄霧兩用機可以使用下列操作模式，機器每次接受一種訊號。

- 手動控制
- 定時控制
- DMX512
- 無線控制
- 無線 DMX

8.1 控制面板說明



F-7X 煙霧薄霧兩用機可以使用機器上的數位控制面板來操作。

圖標	操作方式	動作
✓	按	確認選擇
◆	按	調整數值
↶	按	回到上一頁

圖標	操作方式	動作
	按	啟動
	按	停止
	按	進入設定
 (綠色背景)	N/A	正在運作的模式

8.2 選單說明

主選單	選項	設定值	
定時	操作模式	噴煙 / 噴霧	
	間隔時間	1 - 360 秒	
	啟動時間	1 - 120 秒	
	噴煙噴出量	20 - 100%	
	噴霧噴出量	20 - 100%	
	風扇	20 - 100%	
手動	操作模式	噴煙 / 噴霧	
	噴煙噴出量	1 - 100%	
	噴霧噴出量	20 - 100%	
	風扇	20 - 100%	
DMX	地址	001 - 510	
	W-DMX 電源	開啟 / 關閉	
	W-DMX 重置	開啟	
選單	資訊	軟體版本	
	設定	操作模式	噴煙 / 噴霧
		風量	20 - 180%
		煙油選項	FLG / FLZ / FLH
		油量偵測	開啟 / 關閉
		無線遙控器配對	配對 / 取消配對
		快速啟動	開啟 / 關閉
		語言選項	中文 / English / 日本語
	LCD 背光	高 / 中 / 低 / 自動關閉	
自我清潔模式	自動倒數 180 秒		

9. DMX 說明

9.1 接點說明

本機器提供一個 XLR 3-Pin 和 5-Pin 的 DMX 連接頭。PIN 的接點說明如下：

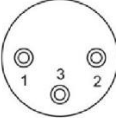
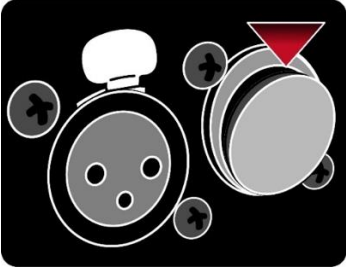
 <p>3 Pin XLR</p>	 <p>5 Pin XLR</p>	<p>**DMX IN 連接頭上有一個保護蓋，操作前，請用手指撥開即可將其取下。</p> 											
<table border="1"> <thead> <tr> <th>Pin</th> <th>功能</th> </tr> </thead> <tbody> <tr> <td>1</td> <td>接地</td> </tr> <tr> <td>2</td> <td>Data-</td> </tr> <tr> <td>3</td> <td>Data+</td> </tr> <tr> <td>4</td> <td>NA</td> </tr> <tr> <td>5</td> <td>NA</td> </tr> </tbody> </table>			Pin	功能	1	接地	2	Data-	3	Data+	4	NA	5
Pin	功能												
1	接地												
2	Data-												
3	Data+												
4	NA												
5	NA												

9.2 DMX 通道功能

本機器提供三種 DMX 通道模式可供選擇，請參考下方表單。

通道模式	頻道	DMX 數值範圍	功能
Channel 1 (通道 1)	1	0 – 127	Faze Mode 薄煙霧模式
		128 – 255	Fog Mode 煙霧模式
Channel 2 (通道 2)	2	0 – 5	Output Off 關閉
		6 – 255	Output 21%– 100%煙霧輸出
Channel 3 (通道 3)	3	0 – 5	Fan Speed 20%風量大小
		6 – 255	Fan Speed 21% – 100%風量大小

10. RDM 功能

M-12 全電壓煙霧機配有 RDM 功能，讓使用者可以經由 DMX 網路使用 RDM 功能進行機台的設定、監控、管理。請參考下表相關 RDM 支援參數；

10.1 RDM UID

ESTA Manufacturer ID (16-bit)		Device ID (32-bit)			
Fixed		Fixed		RDM UID Range: 0x0000 ~ 0xFFDC	
0x1E	0xD8	0x00	0x0C	0x00	0x01

※RDM UID 可於工程模式中設定

10.2 RDM Categories/Parameter ID Defines

GET Allowed	SET Allowed	Category	RDM Parameter ID's	Value	Required
		Network Management	DISC_UNIQUE_BRANCH	0x0001	O
			DISC_MUTE	0x0002	O
			DISC_UN_MUTE	0x0003	O
O		RDM Information	STATUS_MESSAGES	0x0030	
O			SUPPORTED_PARAMETERS	0x0050	O
O		Product Information	DEVICE_INFO	0x0060	O
O			PRODUCT_DETAIL_ID_LIST	0x0070	
O			DEVICE_MODEL_DESCRIPTION	0x0080	
O			MANUFACTURER_LABEL	0x0081	
O	O		DEVICE_LABEL	0x0082	
O			SOFTWARE_VERSION_LABEL	0x00C0	O
O	O	DMX512 Setup	DMX_PERSONALITY	0x00E0	
O			DMX_PERSONALITY_DESCRIPTION	0x00E1	
O	O		DMX_START_ADDRESS	0x00F0	O
O	O	Control	IDENTIFY_DEVICE	0x1000	O

11. EasySwitch 無線控制器(選配)

EasySwitch 無線控制器是 F-7X 煙霧薄霧兩用機的選購配件，包含一個 W-2 無線發射器及 EasySwitch 無線接收器。若您採購的版本已含無線功能，即已安裝至機器上，可直接使用。若是後續採購 EasySwitch 無線控制器，請按照下方說明進行安裝與配對。如果遇到任何困難與問題，請與當地的 Antari 經銷商尋求協助。

11.1 W-2 無線發射器 & EasySwitch 無線接收器

- 發射器：使用 27A 12V 電池
- 收發距離：有效距離為 50 公尺，實際收訊狀況根據現場環境因素而有所不同。
- 如果發現有效距離明顯減少時，請更換電池。
- W-2 無線發射器配有 4 個按鈕，控制功能為：

按鈕	功能
[A] 鍵	啟動噴煙
[B] 鍵	關閉噴煙
[C] 鍵	增加煙霧輸出量
[D] 鍵	減少煙霧輸出量



W-2 無線發射器

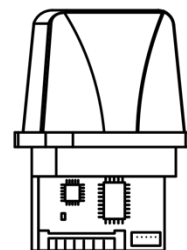

EasySwitch 無線接收器

11.2 EasySwitch 無線接收器安裝說明

如果是後續採購 EasySwitch 無線控制器，請按照下方說明進行安裝與配對。如果遇到任何困難與問題，請與當地的 Antari 經銷商尋求協助。



圖 1



圖 2



圖 3

1. 請看圖一，取下蓋子;
2. 請看圖二，取下後，你會看到一條白色的線，請拉出來接在 EasySwitch 無線接收器上;
3. 請看圖三，將接收器鎖回去原來的地方，然後按照 11.3 的步驟開始配對。

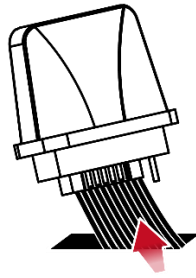
11.3 配對 & 取消配對

每個接收器可以配對最多 5 個控制器，請參考下面步驟配對和取消配對控制器。

步驟 1: 按下選單;

步驟 2: 按下設置，點選無線控制器配對;

步驟 3A: 按下配對，進行配對;

步驟 3B: 按下解除配對，進行解除配對

12. EasySwitch 無線 DMX 接收器(選配)

EasySwitch 無線 DMX 接收器是 F-7X 煙霧薄霧兩用機的選購配件，包含一個無線 DMX 接收器。若您採購的機型包含此功能，即已安裝至機器上，可直接使用。若是後續採購，請按照下方說明進行安裝與配對。如果遇到任何困難與問題，請與當地的 Antari 經銷商尋求協助。

12.1 無線 DMX 接收器

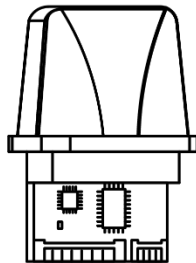

12.2 無線 DMX 接收器安裝說明

如果是後續採購 EasySwitch 無線 DMX 接收器，請按照下方說明進行安裝與配對。如果遇到任何困難與問題，請與當地的 Antari 經銷商尋求協助。



圖 1



圖 2

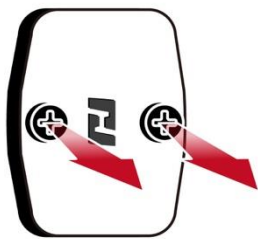

圖 3

4. 請看圖一，取下蓋子;
5. 請看圖二，取下後，你會看到一條白色的線，請拉出來接在 EasySwitch 無線 DMX 接收器上;
6. 請看圖三，將接收器鎖回去原來的地方，然後按照 12.3 的步驟開始配對。

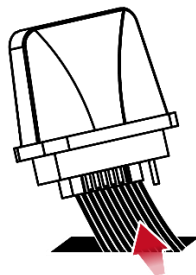
12.3 配對 & 取消配對

請參考下面步驟連接無線 DMX 訊號。

步驟 1：按下 DMX;

步驟 2：按下 W-DMX 電源;

步驟 3A：接按下開啟，連接無線 DMX 訊號;

步驟 3B：按下關閉，斷開無線 DMX 訊號;

步驟 4：或按下 W-DMX 重置，再按下開啟，重置 W-DMX

12.4 無線 DMX 連接狀態說明

LCD 螢幕上所顯示的符號	W-DMX 連結狀態
●	無線發射器已對頻，接收到 DMX 訊號
◎	無線發射器已對頻，但沒有 DMX 訊號
⊙	無線發射器連接遺失 / 正在與發射器連接
○	沒有對頻任何無線發射器

13. 維護和保養

	危險	維修保養之前，請務必拔除電源線。
--	-----------	------------------

- 隨時保持機器清潔及乾燥。
- 可以使用空氣壓縮機、吸塵器或軟刷除去機器上的灰塵。
- 機殼可使用濕布擦拭。
- 在存放機器前或使用機器後，請確認液體已經完全清空並保持乾燥。
- 建議每月至少讓機器運轉一次，以保持機器處於最佳的性能和輸出條件。
- 機器上過多的灰塵、液體殘餘累積的髒污會降低機器工作性能，導致散熱不良。

13.1 重置斷路器 (二合一電源開關)

此二合一開關結合電源和斷路器功能。請依照以下步驟重置斷路器;

步驟 1: 請將此二合一開關切到 OFF 的位置

步驟 2: 等待 60 秒

步驟 3: 再將此二合一開關切到 ON 的位置即完成重置

若重置斷路器後，依然跳掉的話，請與當地 Antari 經銷商聯繫，尋求協助。

斷路器規格

100-120V = 15A 250V

220-240V = 9A 250V

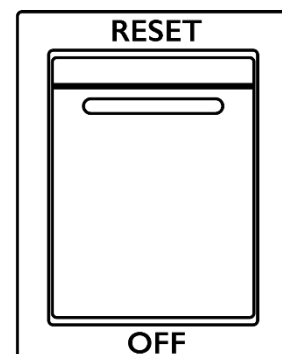

14. 技術規格

F-7X	
電壓	美規 : AC 100-120V, 50/60Hz 13.5A 歐規 : AC 220-240V, 50/60Hz 8.0A
額定功率	100V 1400 瓦 / 120V 1600 瓦 / 240V 1900 瓦
加熱時間	約 8 分鐘(煙霧模式)
耗油量	煙霧模式: 150 毫升/分鐘 (100%輸出) 薄煙霧模式: 28 毫升/分鐘 (100%輸出)
油桶容量	5 公升(1.32 加侖) x 2 個
適用煙霧水	Antari FLG-5E、Antari FLH-5E、Antari FLZ-5E
運作時間	2.8 小時 (100%輸出)(薄煙霧模式)
適用環境溫度	0°C – 40°C (32°F – 104°F)
控制方式	手動控制、定時控制、DMX 512、無線控制(選配)、無線 DMX(選配)
連接座	XLR 3-Pin/5-Pin 連接頭(DMX)、Neutrik powerCON 連接頭(主電源)
DMX 512 通道	3 個頻道
隨附配件	N/A
選購配件	EasySwitch 無線控制器、EasySwitch 無線 DMX
尺寸	長 728 寬 428 高 719 公釐 (長 28.66 寬 16.85 高 28.31 英寸)
重量	53.0 公斤 (116.85 磅)

15. 保固聲明

本公司保證我們的商品在一年內沒有材料和製作缺陷。我們在本保證下的義務和責任僅限於在原廠或當地授權經銷商進行的維修或更換。我們對不當使用或用於非專門設計目的以外之用途不承擔任何責任。本保固不適用於以任何方式在原廠或當地授權經銷商外修理、改動或組裝的任何商品，以便我們判斷影響其性能，沒有受到誤用、疏忽或事故的影響，也沒有違反我們的任何商品操作印刷說明。本公司對於從我們這邊購買的商品不會允許也不對於使用、銷售或修理任何產品有關的任何類型的任何損失或損害承擔責任。

16. 機器尺寸圖

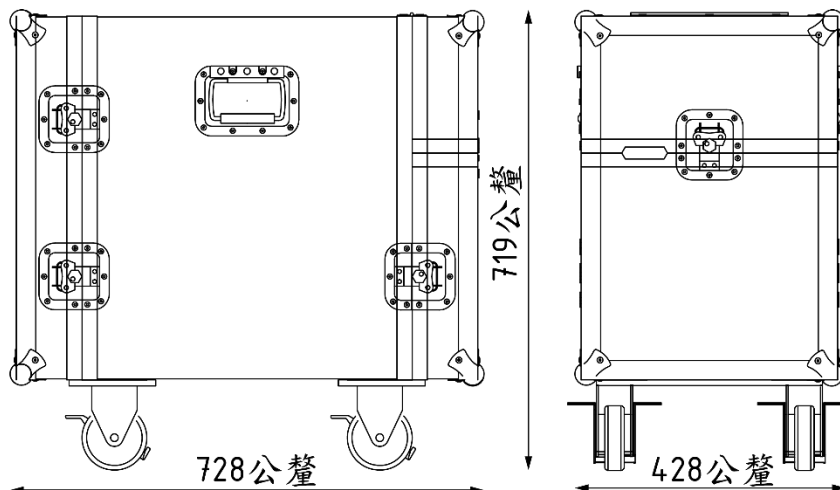

Appendix I Grounding Instruction

This appliance must be grounded. In the event of malfunction or breakdown, grounding provides a path of least resistance for electric current to reduce the risk of electric shock. This appliance is equipped with a cord having an equipment-grounding conductor and a grounding plug. The plug must be plugged into an appropriate outlet that is properly installed and grounded in accordance with all local codes and ordinances.

DANGER – Improper connection of the equipment-grounding conductor can result in a risk of electric shock. The conductor with insulation having an outer surface that is green with or without yellow stripes is the equipment-grounding conductor. If repair or replacement of the cord or plug is necessary, do not connect the equipment-grounding conductor to a live terminal. Check with a qualified electrician or serviceman if the grounding instructions are not completely understood, or if in doubt as to whether the appliance is properly grounded. Do not modify the plug provided with the appliance – if it will not fit the outlet, have a proper outlet installed by a qualified electrician.

This appliance is for use on a nominal 120 V circuit, and has a grounding plug that looks like the plug illustrated in sketch A in Figure. A temporary adaptor, which looks like the adaptor illustrated in sketches B and C, may be used to connect this plug to a 2-pole receptacle as shown in sketch B if a properly grounded outlet is not available. The temporary adaptor should be used only until a properly grounded outlet can be installed by a qualified electrician. The green colored rigid ear, lug, and the like, extending from the adaptor must be connected to a permanent ground such as a properly grounded outlet box cover. Whenever the adaptor is used, it must be held in place by the metal screw.

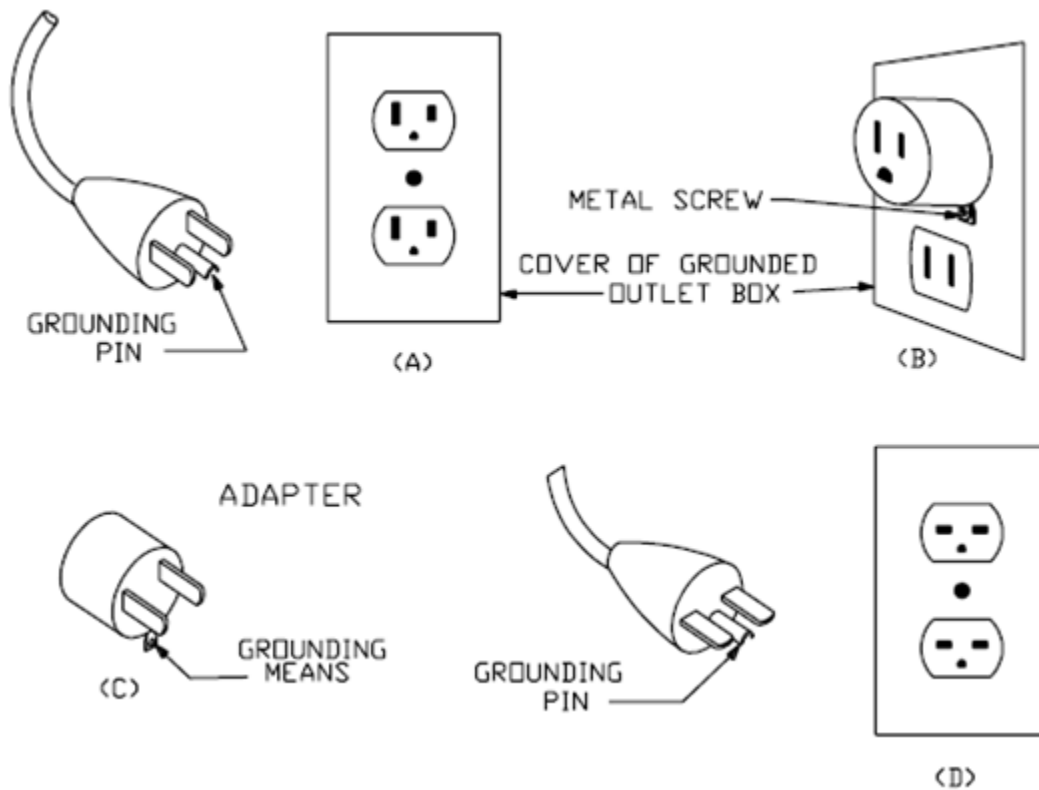



C08F7X001